

SERVICE MANUAL

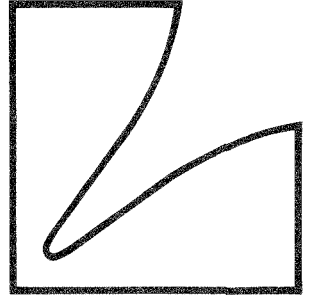

Stereo Preamplifier

C-03

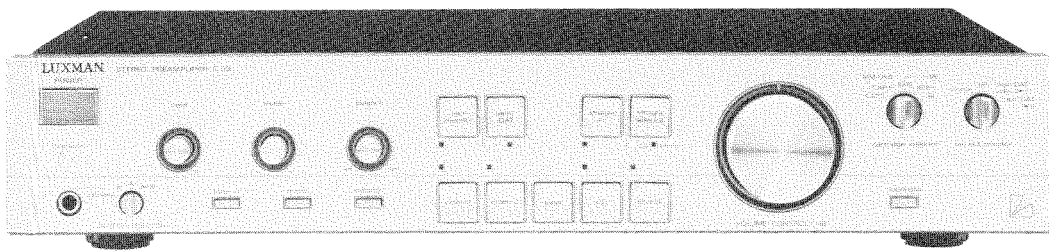

Contents

Specifications	3
Parts Locations and Disassembly Instructions	4 to 5
Adjustment Procedures	6
Adjustment Locations	7
Block Diagram	8
Parts Layout on P. C. Boards and Wiring Diagram	9 to 14
Schematic Diagram	15 to 17
Electrical Parts List	18 to 22
Cabinet Assembly Parts List	23
Exploded View (Cabinet)	24 to 25
Packing Assembly Parts List	26
Packing Method View	26
Semi-Conductor Lead Identifications	27 to 29

Specifications

Output Voltage	1V
Input Sensitivity (at 1kHz)	CD : 150mV \pm 15%
	Tuner : 150mV \pm 15%
	Phono (MM) 47k ohm, Cap-1 : 2.5V \pm 15%
	Phono (MM) 47k ohm, Cap-2 : 2.5V \pm 15%
	Phono (MC) 3 ohm : 0.1mV \pm 15%
	Phono (MC) 40 ohm : 0.22mV \pm 15%
	Phono (MC) 100 ohm : 0.22mV \pm 15%
	Monitor-1, 2 (Tape/DAT) : 150mV \pm 15%
	Video-1, 2 : 150mV \pm 15%
Input Impedance (at 1kHz)	CD : 32k ohm \pm 20%
	Tuner : 32k ohm \pm 20%
	Phono (MM) 47k ohm, Cap-1 : 47k ohm \pm 20%
	Phono (MM) 47k ohm, Cap-2 : 47k ohm \pm 20%
	Phono (MC) 3 ohm : 120 ohm \pm 20%
	Phono (MC) 40 ohm : 40 ohm \pm 20%
	Phono (MC) 100 ohm : 100 ohm \pm 20%
	Monitor-1, 2 (Tape/DAT) : 32k ohm \pm 20%
	Video-1, 2 : 32k ohm \pm 20%
Total Harmonic Distortion (at 1kHz)	CD, Tuner (Pre-Out : 2V) : 0.01%
	Phono (MM) (Rec-Out : 5V) : 0.01%
	Video-1, 2 (Pre-Out : 2V) : 0.01%
Frequency Response	CD, Tuner 20~100kHz : \pm 1.5dB
	Phono (MM) (Rec-Out 1V) 100Hz : \pm 0.5dB
	10kHz : \pm 0.5dB
	Video-1, 2 20~100kHz \pm 0.5dB
	Tape Monitor-1, 2 (DAT/ Monitor-1, 2) 20~100kHz : \pm 1.5dB
	Video, Monitor-1, 2 20~100kHz : \pm 1.5dB
Tone Control	Bass (100Hz) : \pm 6 \pm 1.5dB
	Treble (10kHz) : \pm 6 \pm 1.5dB
Loudness (VR-30dB)	100Hz : +6 \pm 1.5dB
	10kHz : +4 \pm 1.5dB
S/N Ratio (Input Terminal Shorted)	CD, Tuner, Video-1,2 : 77.8dB
	Phono (MM) Cap-1 : 43.8dB
	Phono (MC) 3 ohm : 43.8dB
	Phono (MC) 40 ohm : 43.8dB
	Phono (MC) 100 ohm : 43.8dB
	Monitor-1, 2 (DAT-1, 2) : 77.8dB
Residual Noise	Volume, minimum : 88.2dB
Cross Talk (Pre-Out 5V=0dB, Input Terminal Shorted at 1kHz)	CD : -70dB
	Tuner : -70dB
	Video-1, 2 : -70dB
	Phono (MM) : -70dB
	Monitor-1, 2 : -70dB
Power Supply	120V, 60Hz (UQ Model only)
	100/120/220/240V, 50Hz (AD Model only)
Semiconductors	6 IC's, 61 Transistors, 8 FETs,
	18 Diodes, 11 Zener Diodes
Dimensions	438 (W) \times 328 (D) \times 88 (H) mm
Weight	5.5kg

NOTE : Due to continuing product improvement, specifications and design are subject to change without notice.

Parts Locations and Disassembly Instructions

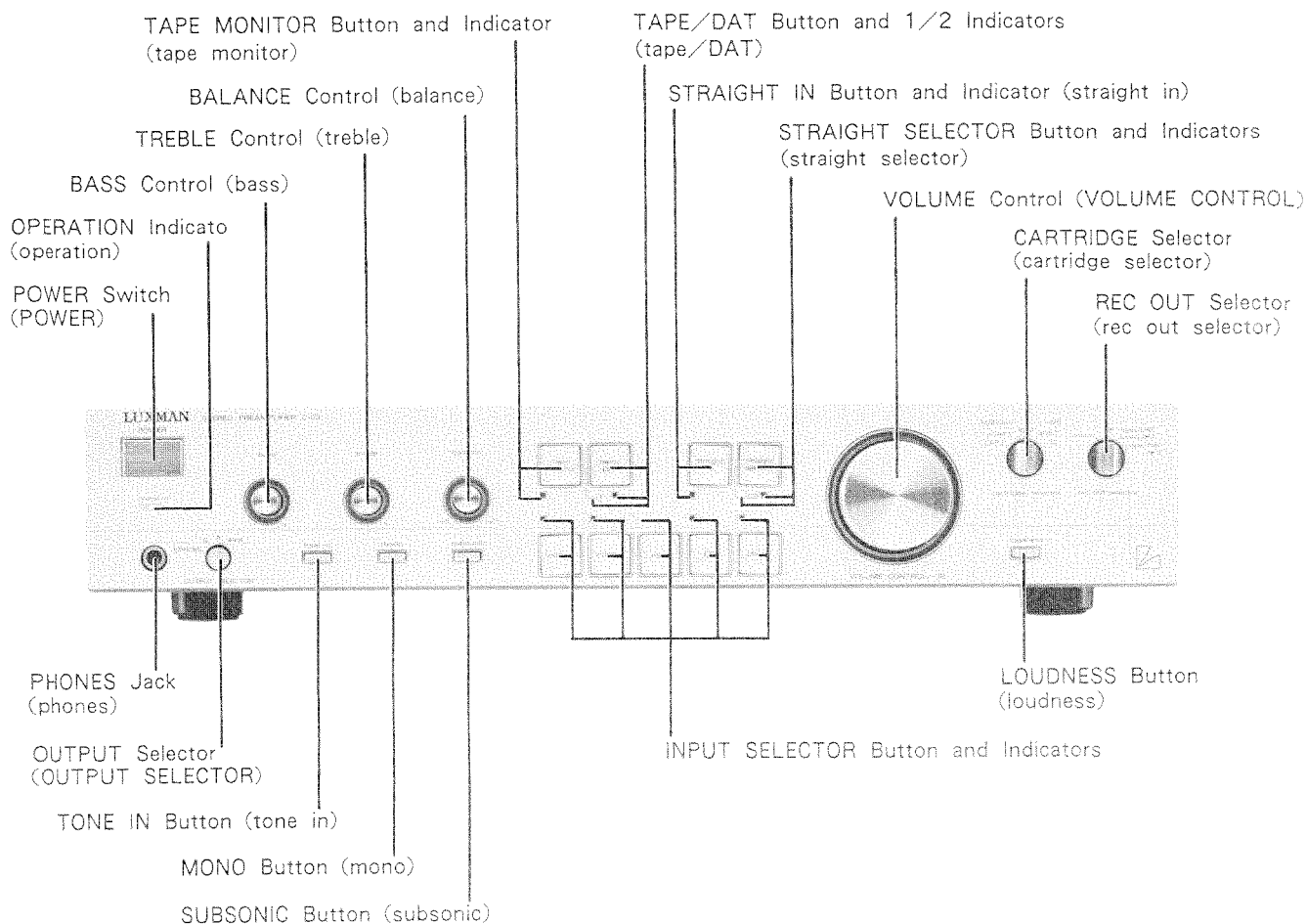

Figure 1

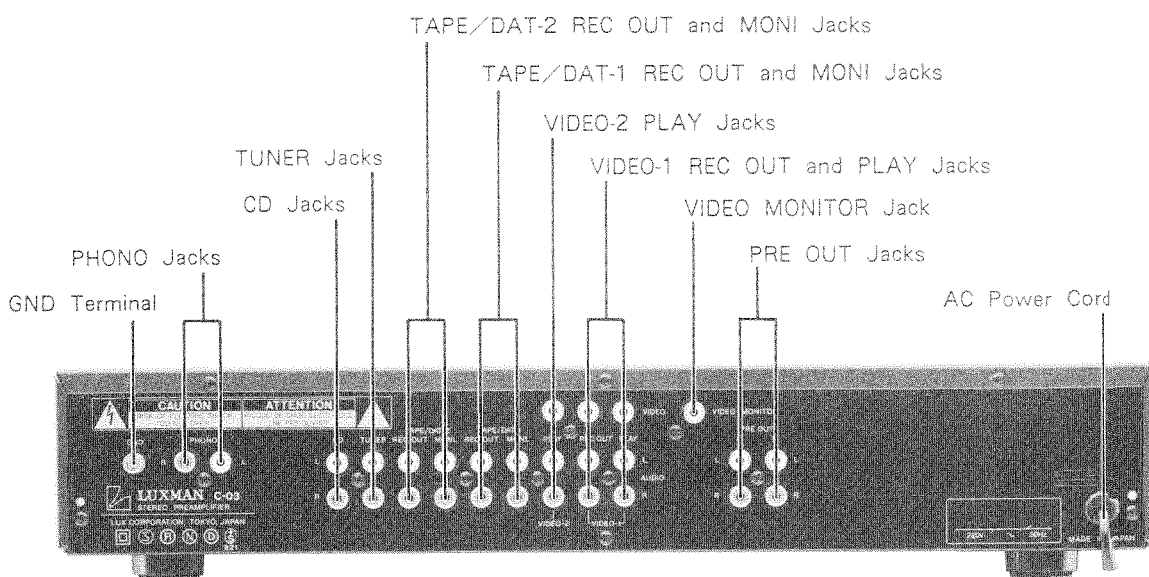

Figure 2

1. Removal of Main P. C. Board

(1) After removal of the top cover and front panel, remove ten screws marked "O" as shown in Figure 3 and 4.

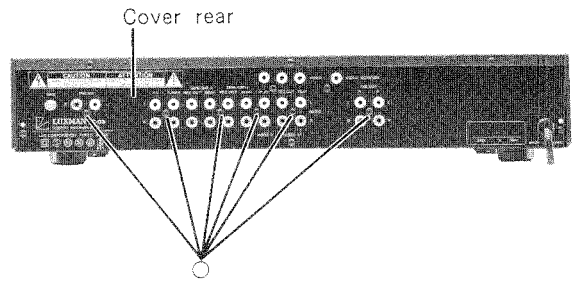
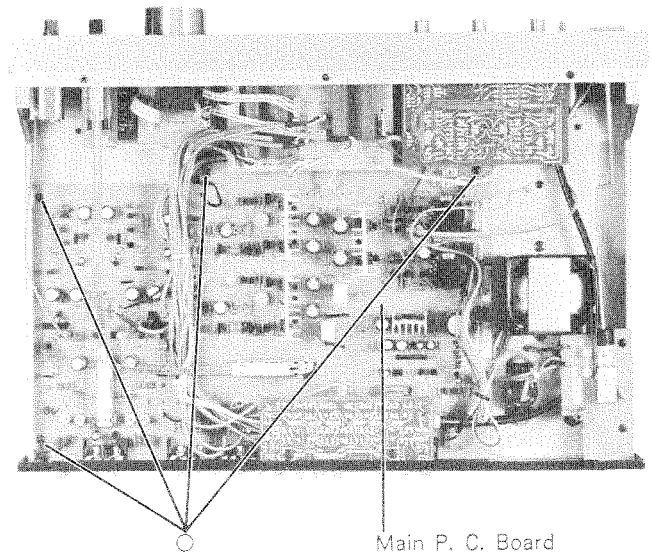

Figure 3

(2) Remove three control knobs, (output selector/ cartridge selector/rec out selector) as shown in Figure 5.



Main P. C. Board

Figure 4

(3) Remove three nuts as shown in Figure 5.

(4) Disconnect all wires from the Main P. C. Board.

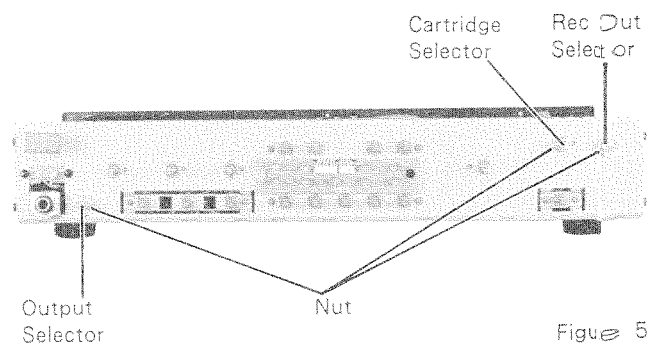
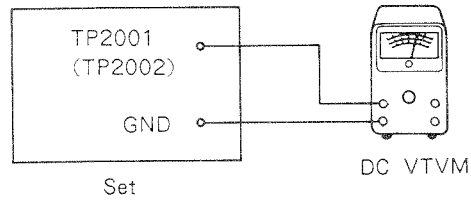

Figure 5

Adjustment Procedures

1. Connection



2. Control Settings

- Treble, Bass, Balance Control Knobs Center Position
- Volume Control Knob Maximum
- Input Selector PHONO

- Cartridge Selector Switch MM
- Others OFF

3. Adjustment Procedures

- PHONO Amp. DC Offset Adjustment
- Confirm that the voltage (DC Offset Voltage) is $0 \pm 10\text{mV}$ at TP2001 (TP2002).
- 1. The voltage shows more than 10mV ($> +10\text{mV}$)
..... Remove R2077 (R2078)
- 2. The voltage shows less than -10mV ($< -10\text{mV}$)
..... Remove R2075 (R2076)

Adjustment Locations

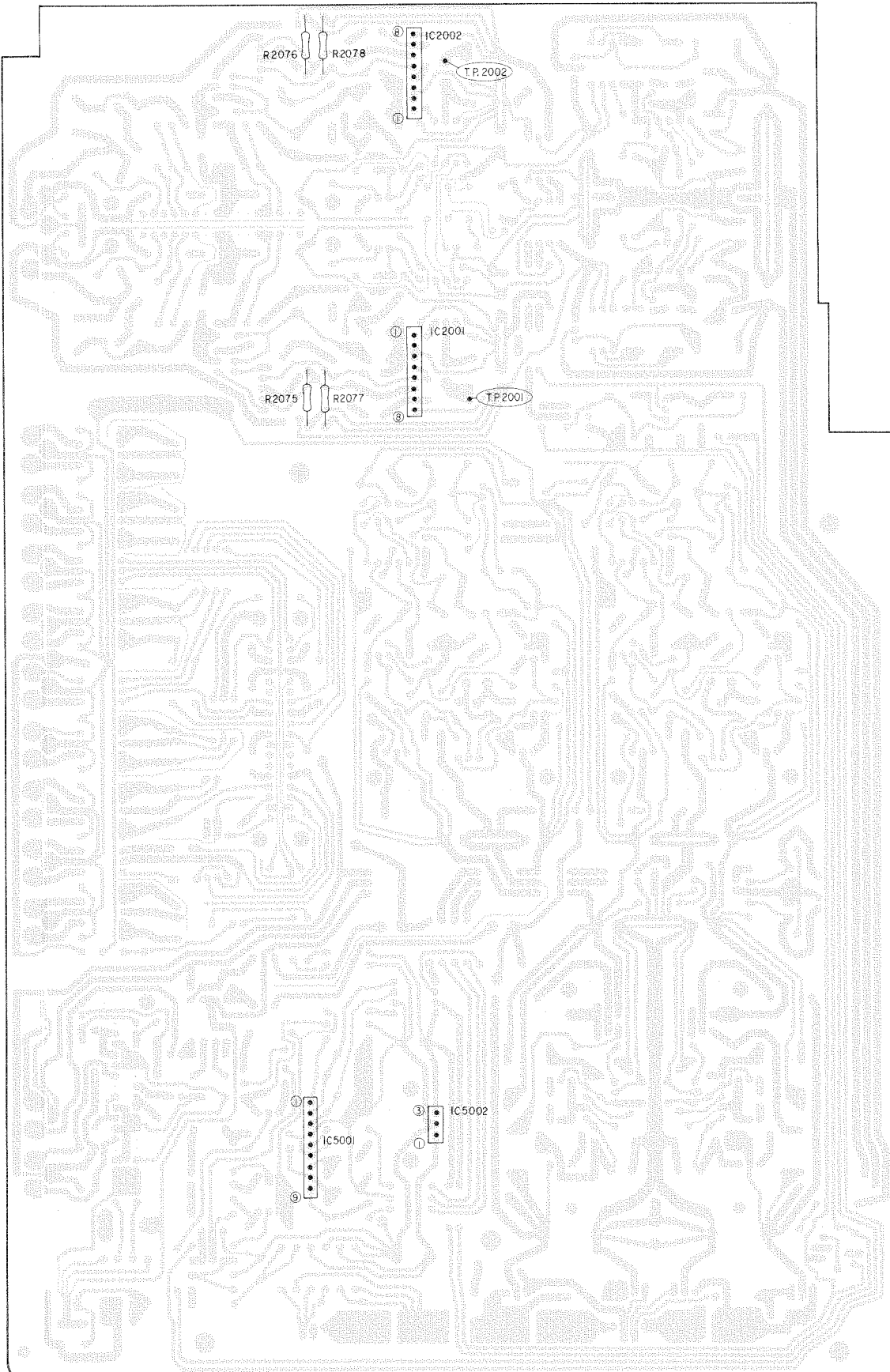

Block Diagram

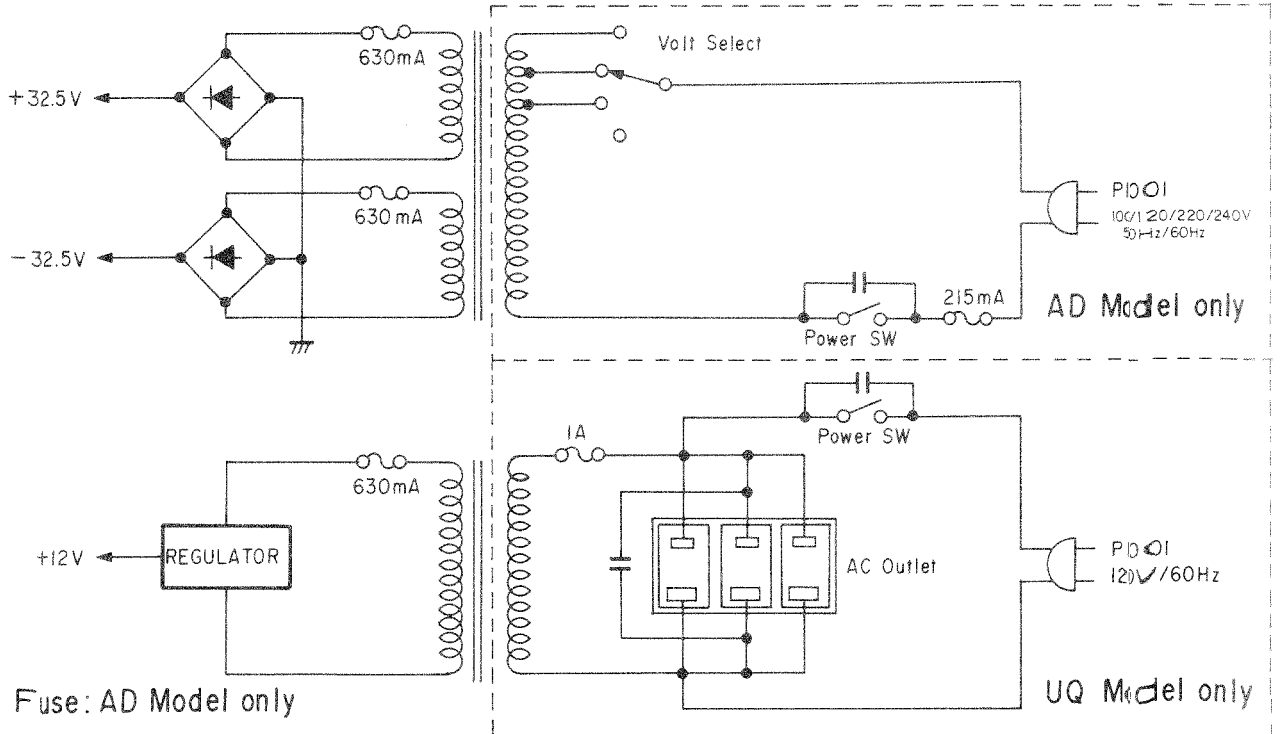
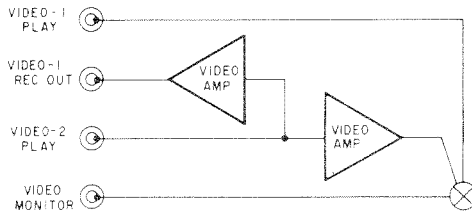
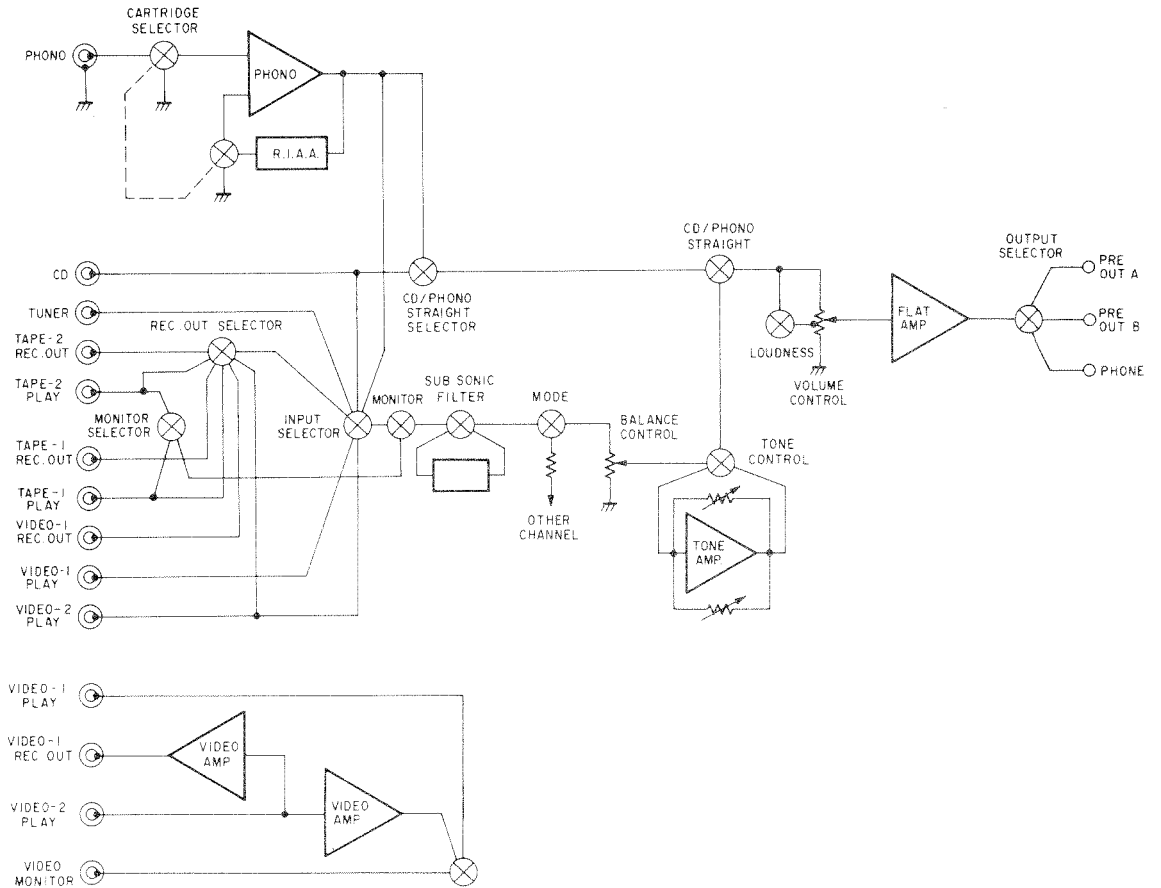

Parts Layout on P.C. Boards and Wiring Diagram (1/2)

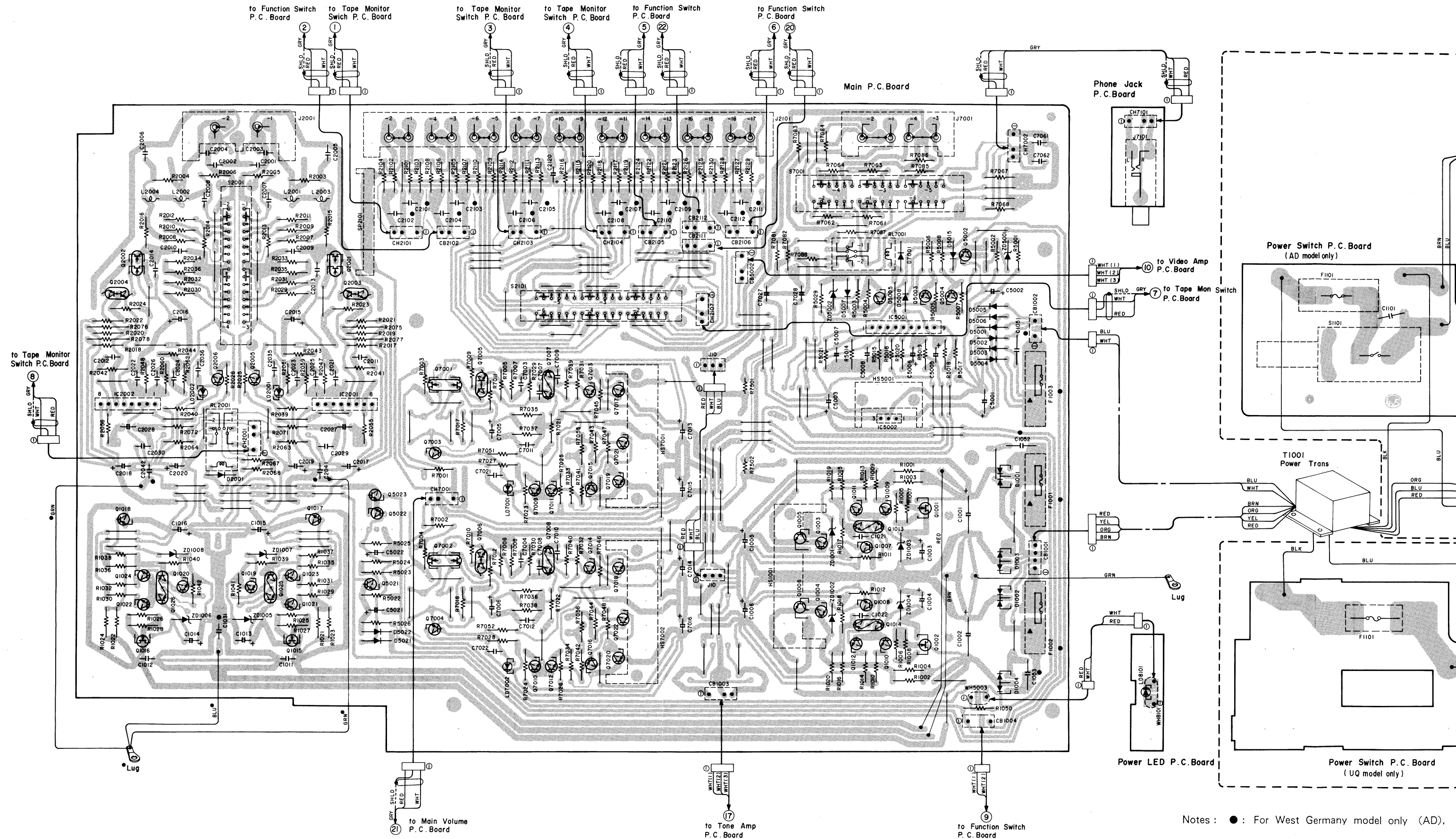

Notes : ● : For West Germany model only (AD).

Diagram (1/2)

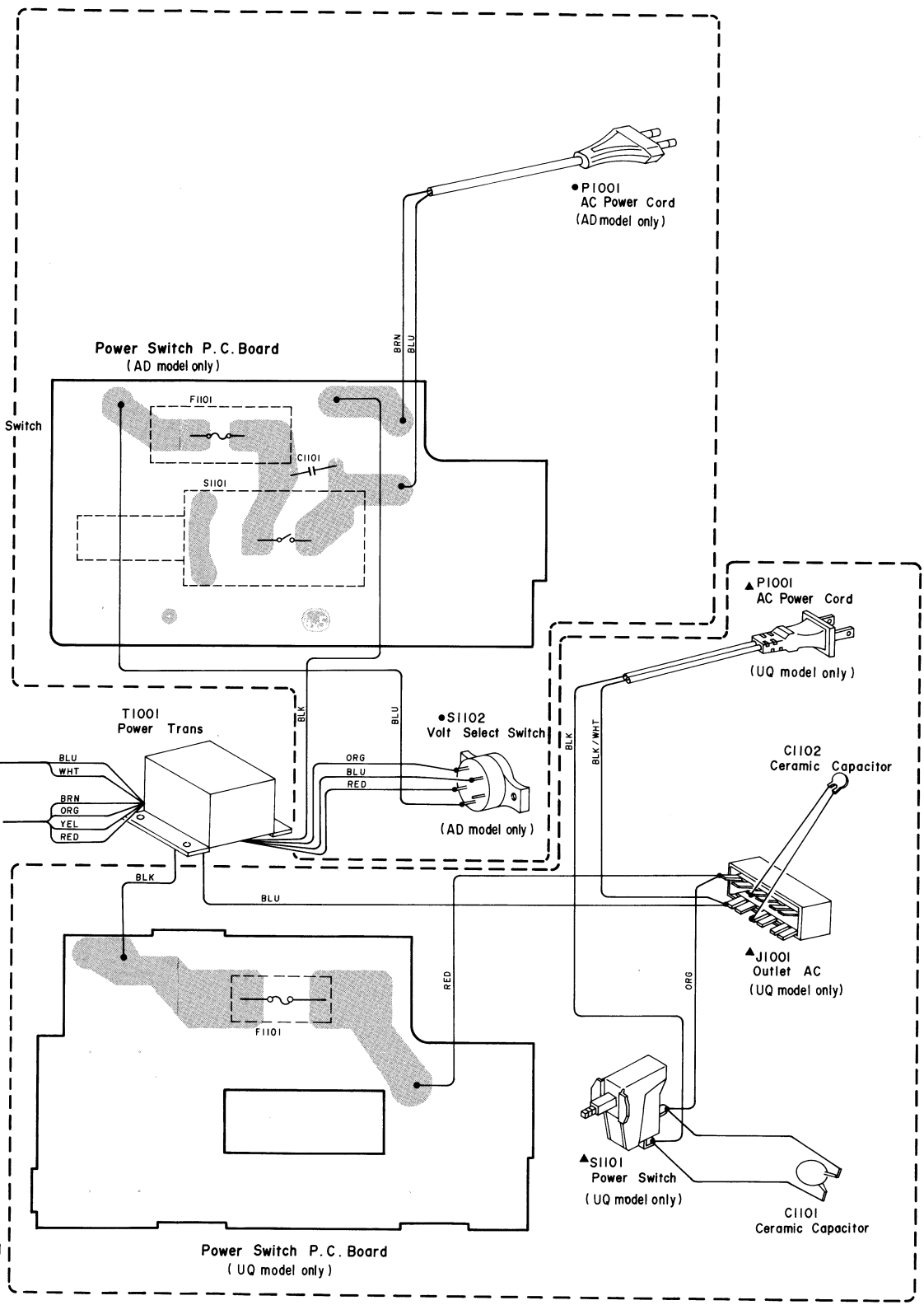
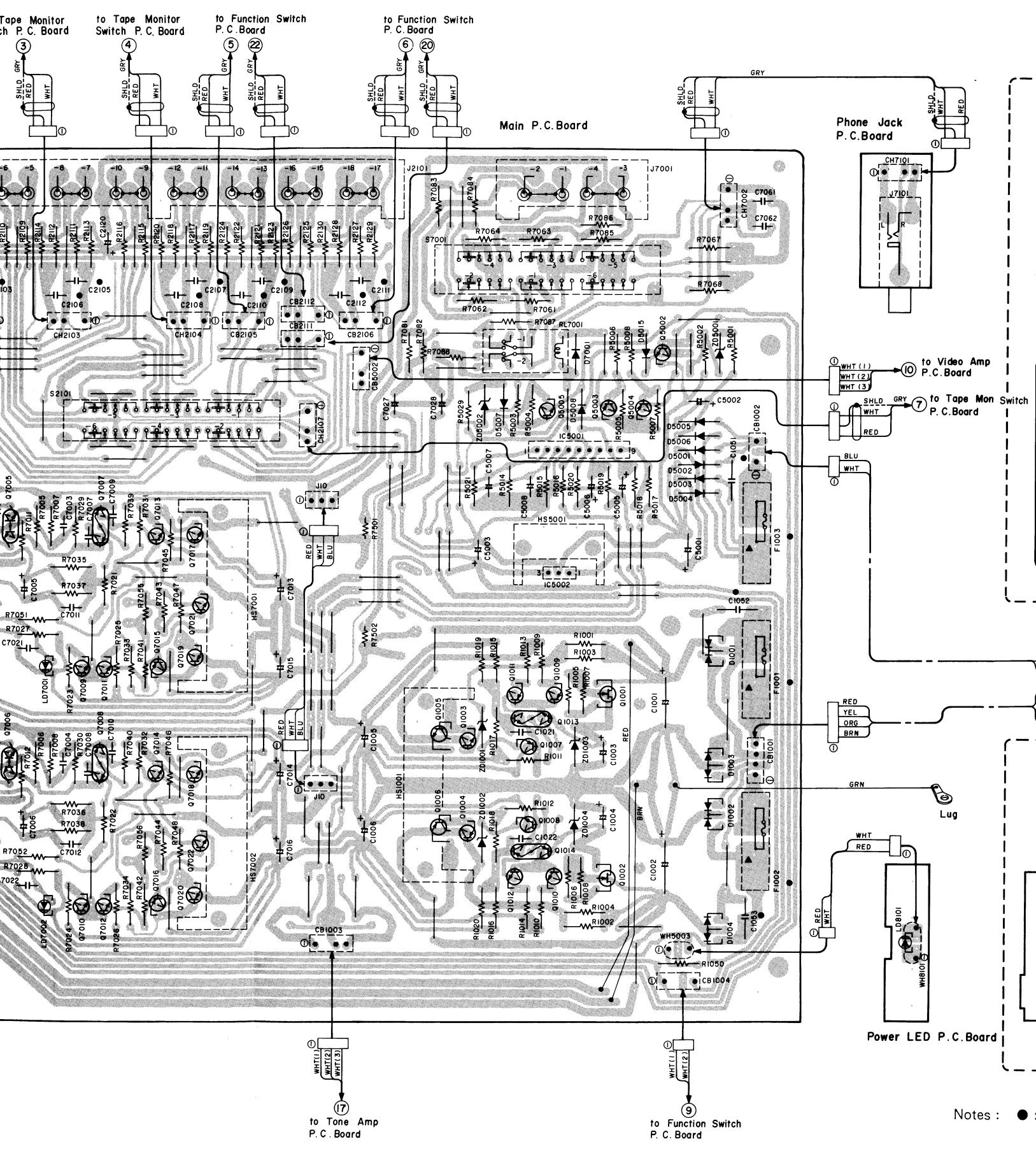

- BLU Blue
- GRN Green
- BLK Black
- GRY Gray
- WHT White
- RED Red
- BRN Brown
- ORG Orange
- YEL Yellow
- VIO Violet
- PNK Pink
- GRN/WHT Green/White
- GRY/WHT Gray/White
- GRN/YEL Green/Yellow
- SHLD Shield

Notes : ● : For West Germany model only (AD), ▲ : For Canadian model only (UQ), Others : Common.

Parts Layout on P.C. Boards and Wiring Diagram (2/2)

- BLU Blue
- GRN Green
- BLK Black
- GRY Gray
- WHT White
- RED Red
- BRN Brown
- ORG Orange
- YEL Yellow
- VIO Violet
- PNK Pink
- GRN/WHT Green/White
- GRY/WHT Gray/White
- GRY/YEL Gray/Yellow
- GRN/YEL Green/Yellow
- SHLD Shield

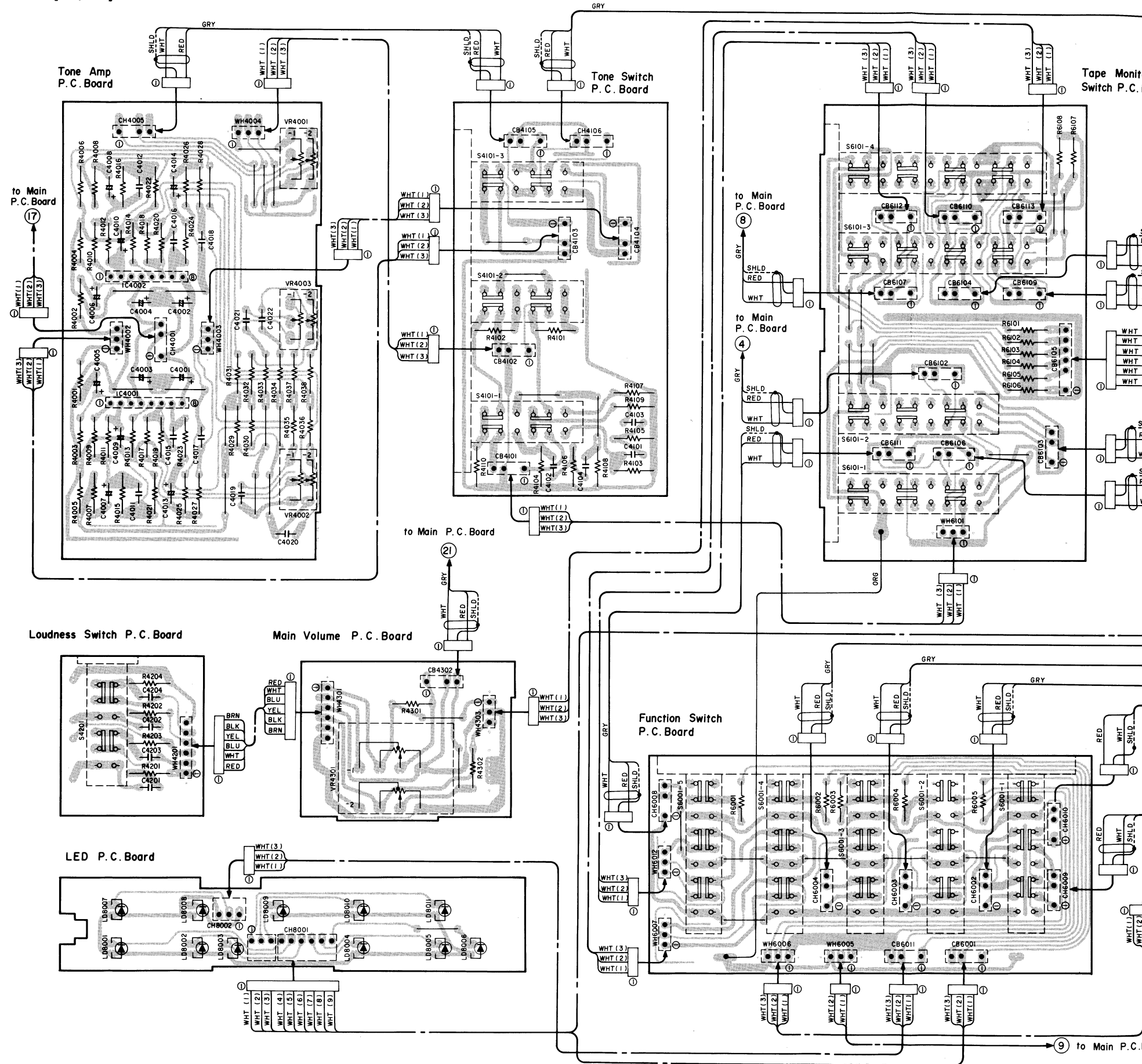
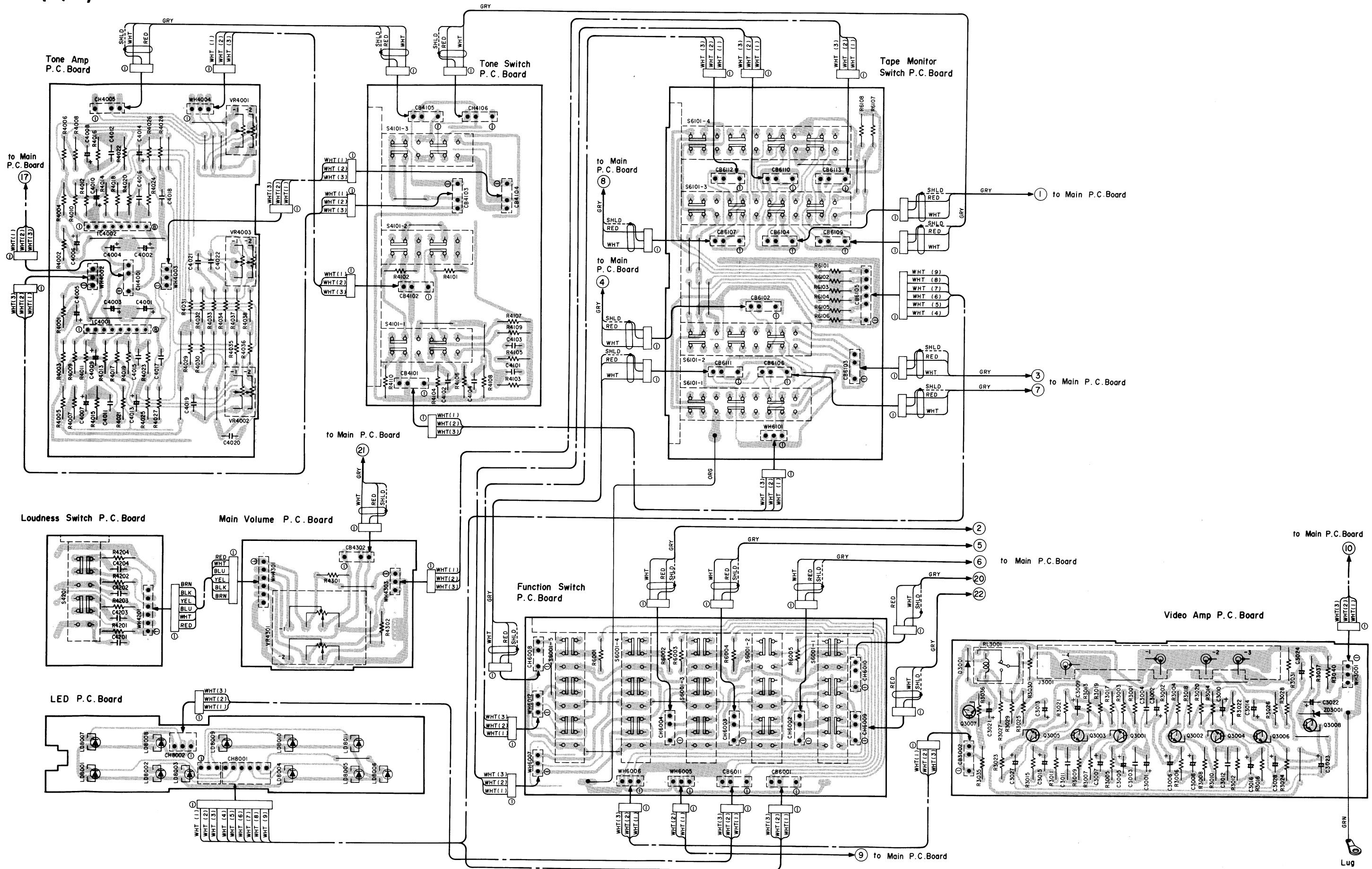
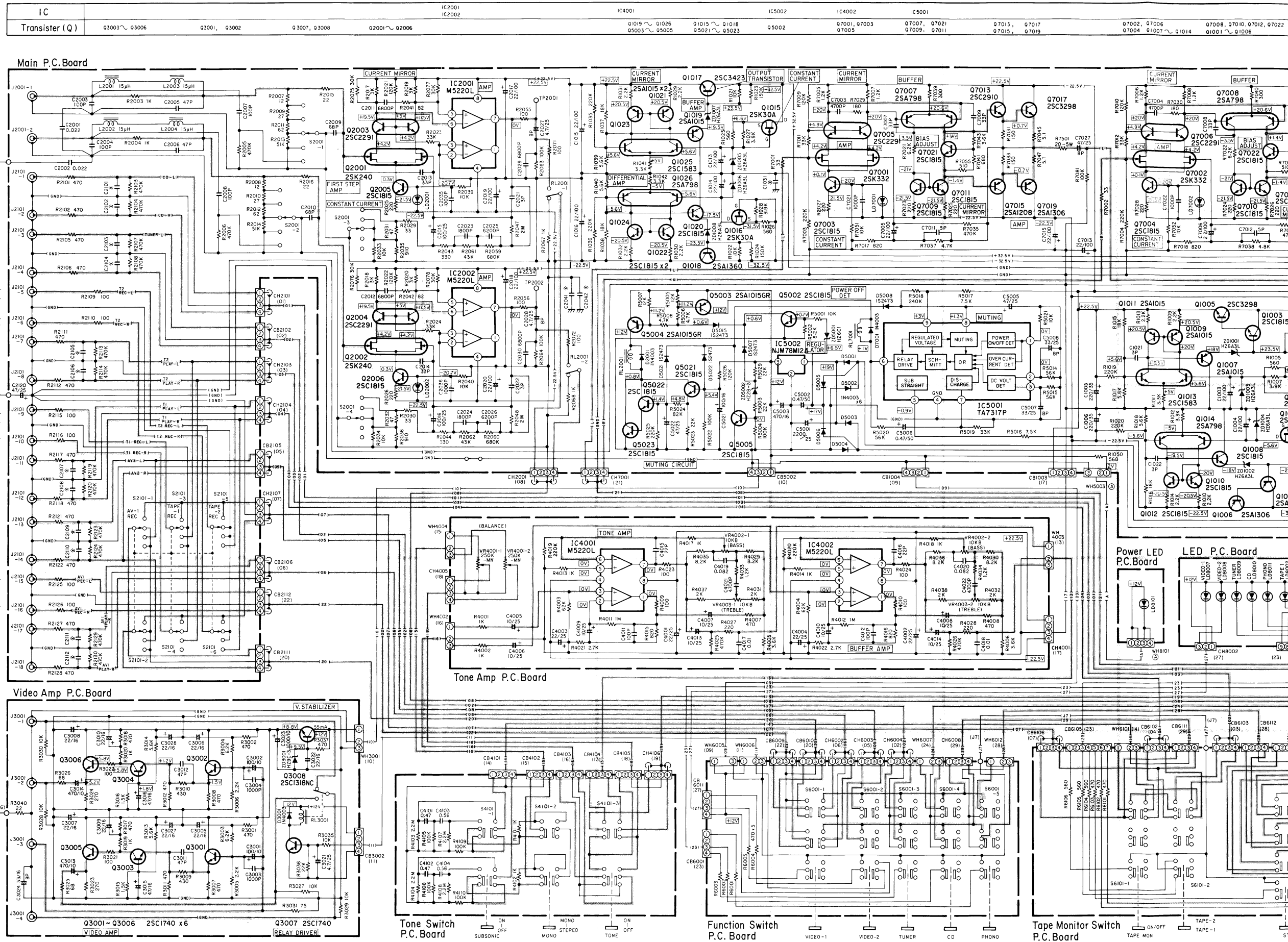

Diagram (2/2)



Schematic Diagram



NOTES:

1. All resistance values are in ohms. K = 1,000
2. All capacitance values are in microfarads. P = $\frac{1}{1,000,000}$

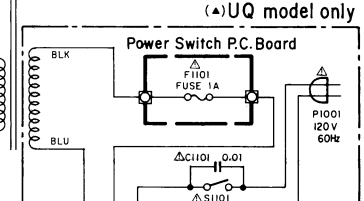
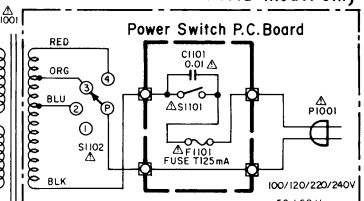
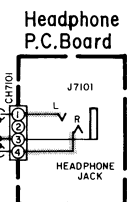
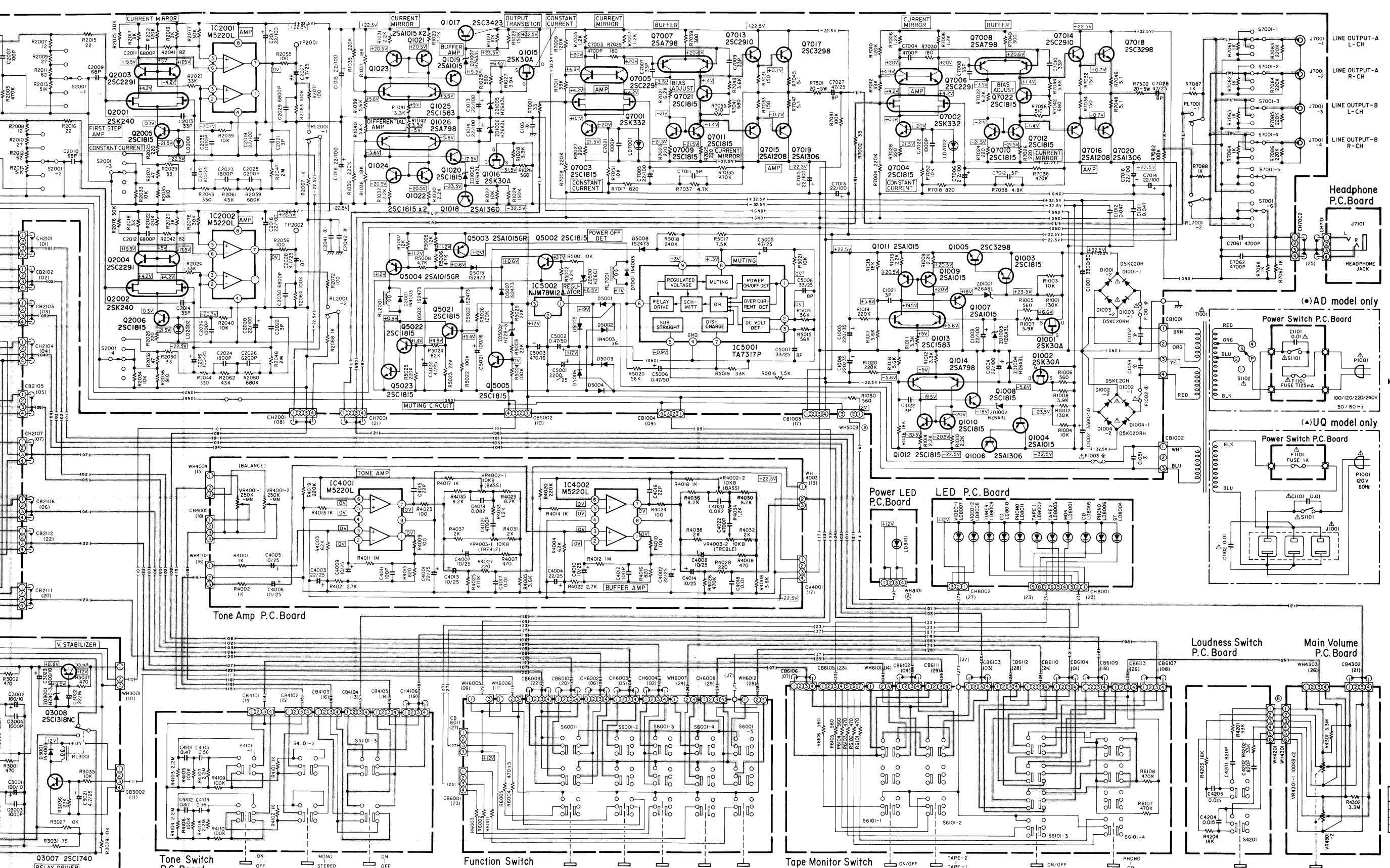

Measuring Condition
 1. Power Supply Voltage
 AC 100/120/220/240V
 50Hz/60Hz (AD model only)
 AC 120V 60Hz (UQ model only)
 2. Measuring Meter
 : Digital Multimeter
 3. Measuring Point Reference
 : Between GND
 4. Measuring Condition
 : No Signal Input

CAUTION:
 The Δ mark, the symbol No. in a box in the schematic diagram and the shaded area in the parts list designate components which have special characteristics important for safety and should be replaced only with types identical to those in the original circuit or specified in the parts list.

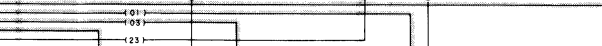
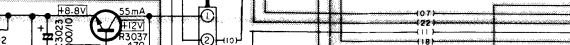

NOTES:
 1. All resistance values are in ohms. K = 1,000
 2. All capacitance values are in microfarads. P = $\frac{1}{1,000,000}$

DESCRIPTION ON MARKS OF Φ	MODEL	AD Model only (Φ)	UQ Model only (Δ)
C1051~1053	0.01 μ F	X	X
C1031,2041,2042	0.022 μ F	X	X
C2101~2112	470P/F	X	X
F1001~1003	T630mA Jumper	X	X

X: Not Used

Schematic Diagram

IC	IC2001	IC2002	IC4001	IC5002	IC4002	IC5001						
Transister (Q)	Q3003 ~ Q3006	Q3001, Q3002	Q3007, Q3008	Q2001 ~ Q2006	Q1019 ~ Q1026 Q5003 ~ Q5005	Q1015 ~ Q1018 Q5021 ~ Q5023	Q5002	Q7001, Q7003 Q7005	Q7007, Q7021 Q7009, Q7011	Q7013, Q7017 Q7015, Q7019	Q7002, Q7006 Q7004, Q1007 ~ Q1014	Q7008, Q7010, Q7012, Q7022 Q1001 ~ Q1006

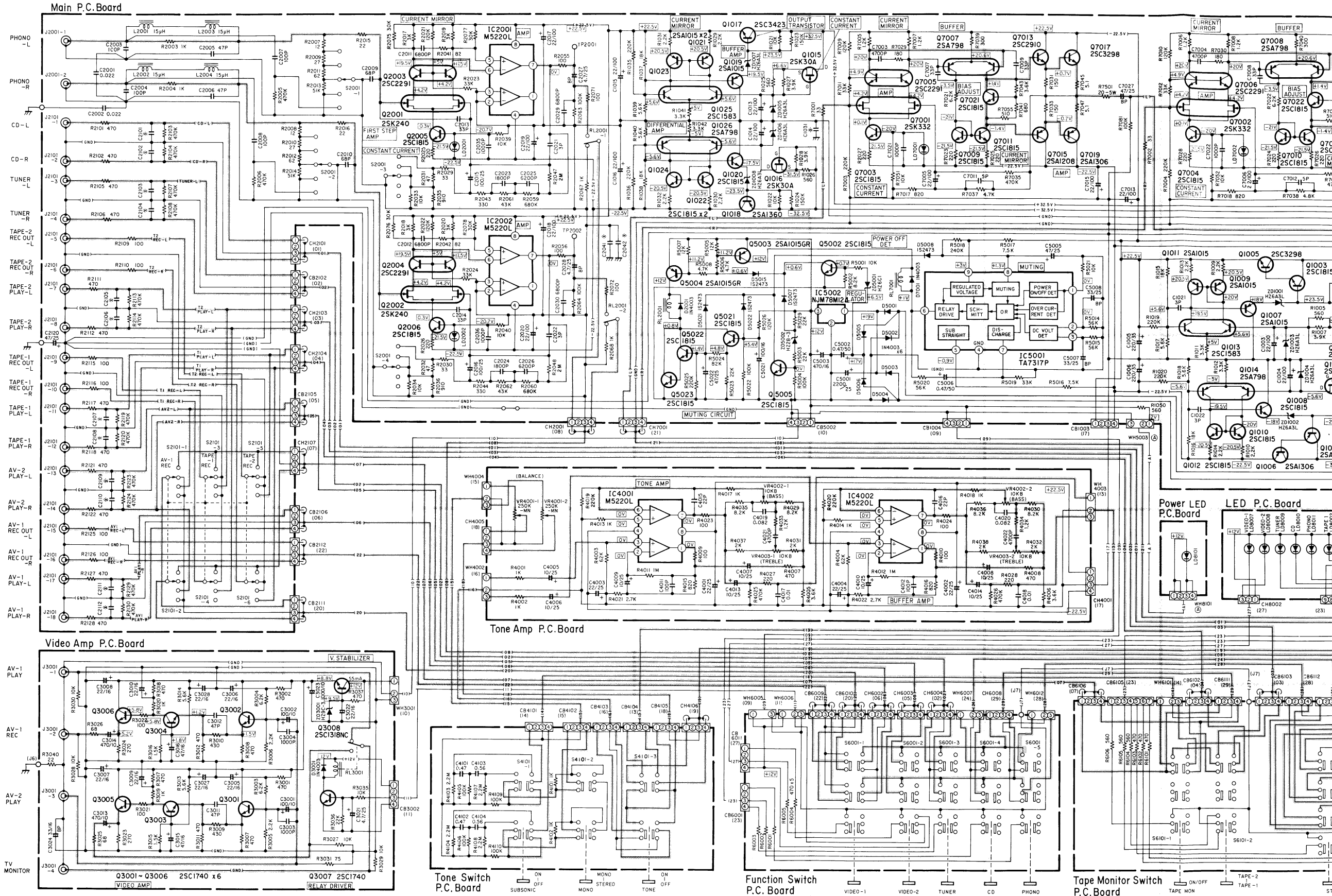

- NOTES:**
1. All resistance values are in ohms. K = 1,000
 2. All capacitance values are in microfarads. P = $\frac{1}{1,000,000}$

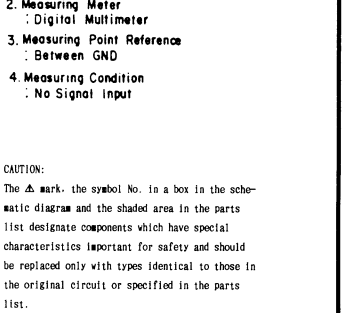
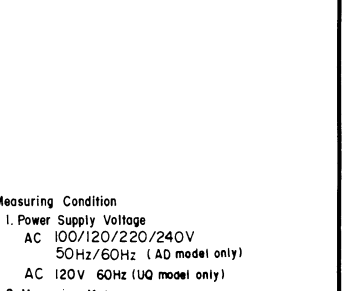
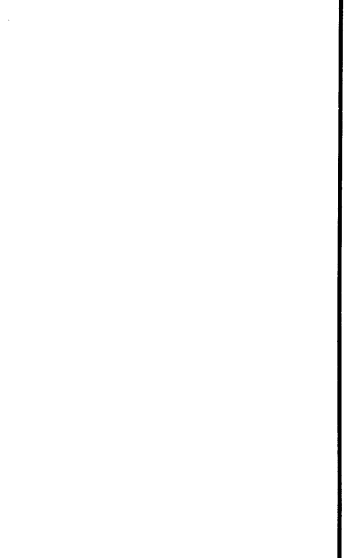
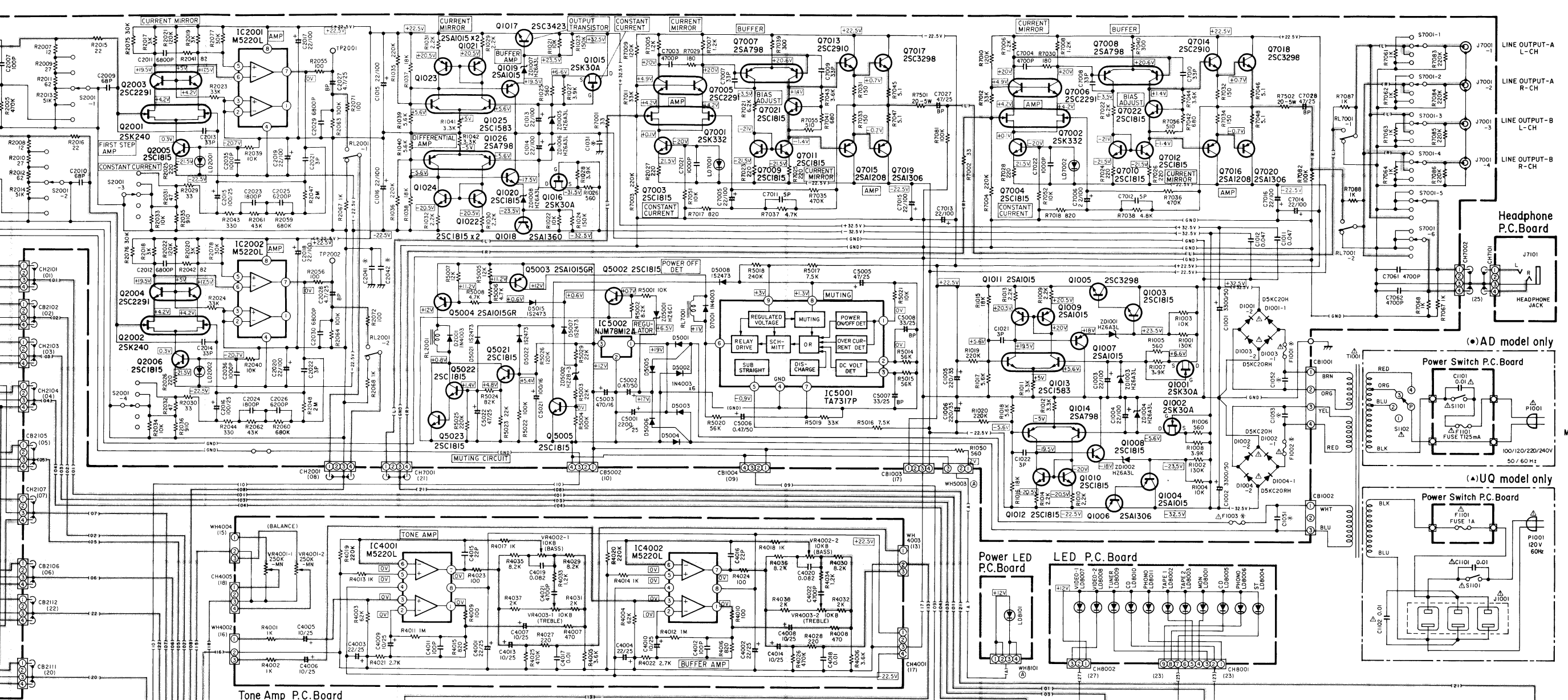

Measuring Condition
 1. Power Supply Voltage
 AC 100/120/220/240V
 50Hz/60Hz (AD model only)
 AC 120V 60Hz (UQ model only)
 2. Measuring Meter
 : Digital Multimeter
 3. Measuring Point Reference
 : Between GND
 4. Measuring Condition
 : No Signal Input

CAUTION:
 The Δ mark, the symbol No. in a box in the schematic diagram and the shaded area in the parts list designate components which have special characteristics important for safety and should be replaced only with types identical to those in the original circuit or specified in the parts list.

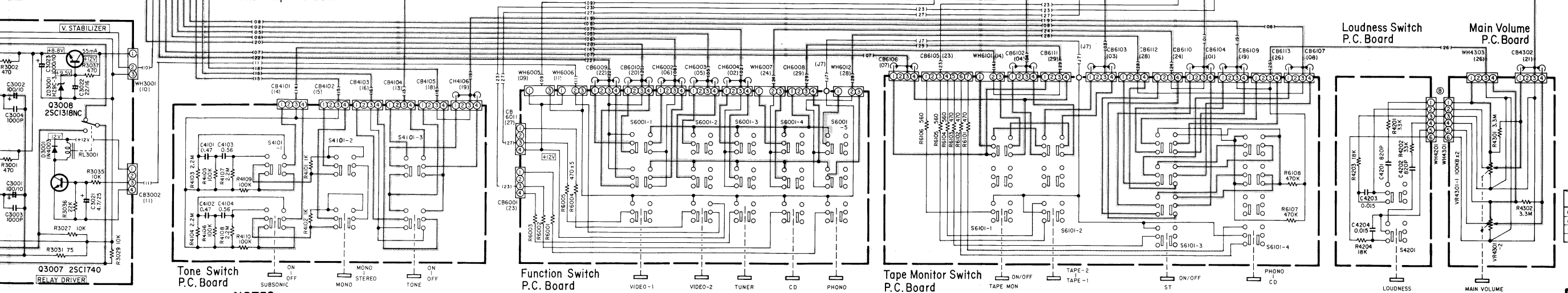

NOTES:
 1. All resistance values are in ohms. K = 1,000
 2. All capacitance values are in microfarads. P = $\frac{1}{1,000,000}$

DISCRPTION ON MARKS OF Φ

MODEL	AD Model only (A)	UQ Model only (U)
C1051~1053	0.01 μ F	X
C1031,2041,2042	0.022 μ F	X
C2101~2112	470PF	X
F1001~1003	T630mA	Jumper

X: Not Used

Electrical Parts List

Resistor : Carbon resistors under 1/4 watts are not mentioned in the parts list, please confirm them by schematic diagram.
 uF=microfarads, pF=picofarads

Abbreviations					Symbol No.	Part No.	Description		
RES.=Resistor CAP.=Capacitor C.F.=Carbon Film ELY.=Electrolytic M.F.=Metal Film CER.=Ceramic M.O.=Metal Oxide Film MYL.=Mylar M.P.=Metal Plate TAN.=Tantalum TR.=Transistor POLY.=Polystyrol TRANS.=Transformer PP.=Polypropylene CP.=Chip PLT.=Polyethylene					Symbol No.	Part No.	Description		
Main P. C. Board									
IC's									
IC2001	51T72167F01	M5220L			Q1026	48T43816F02	2SA798		
IC2002	51T72167F01	M5220L			Q2001	48T60558F01	FET, 2SK240		
IC5001	51T67437F01	TA7317P			Q2002	48T60558F01	FET, 2SK240		
IC5002	51T72375F01	NJM78M12A			Q2003	48T72598F01	2SC2291		
Transistors					Q2004	48T72598F01	2SC2291		
Q1001	48T52152F01	FET, 2SK30A			Q2005	48T81101F01	2SC1815		
Q1002	48T52152F01	FET, 2SK30A			Q2006	48T81101F01	2SC1815		
Q1003	48T81101F01	2SC1815			Q5002	48T81101F01	2SC1815		
Q1004	48T81102F01	2SA1015			Q5003	48T51118F02	2SA1015		
Q1005	48T60555F01	2SC3298			Q5004	48T51118F02	2SA1015		
Q1006	48T60556F01	2SA1306			Q5005	48T81101F01	2SC1815		
Q1007	48T81102F01	2SA1015			Q5021	48T81101F01	2SC1815		
Q1008	48T81101F01	2SC1815			Q5022	48T81101F01	2SC1815		
Q1009	48T81102F01	2SA1015			Q5023	48T81101F01	2SC1815		
Q1010	48T81101F01	2SC1815			Q7001	48T72887F01	FET, 2SK332		
Q1011	48T81102F01	2SA1015			Q7002	48T72887F01	FET, 2SK332		
Q1012	48T81101F01	2SC1815			Q7003	48T81101F01	2SC1815		
Q1013	48T44982P01	2SC1583G			Q7004	48T81101F01	2SC1815		
Q1014	48T43816F02	2SA798			Q7005	48T72598F01	2SC2291		
Q1015	48T52152F01	FET, 2SK30A			Q7006	48T72598F01	2SC2291		
Q1016	48T52152F01	FET, 2SK30A			Q7007	48T43816F02	2SA798		
Q1017	48T64376F01	2SC3423			Q7008	48T43816F02	2SA798		
Q1018	48T64375F01	2SA1360			Q7009	48T81101F01	2SC1815		
Q1019	48T81102F01	2SA1015			Q7010	48T81101F01	2SC1815		
Q1020	48T81101F01	2SC1815			Q7011	48T81101F01	2SC1815		
Q1021	48T81102F01	2SA1015			Q7012	48T81101F01	2SC1815		
Q1022	48T81101F01	2SC1815			Q7013	48T72889F01	2SC2910		
Q1023	48T81102F01	2SA1015			Q7014	48T72889F01	2SC2910		
Q1024	48T81101F01	2SC1815			Q7015	48T72888F01	2SA1208		
Q1025	48T44982P01	2SC1583G			Q7016	48T72888F01	2SA1208		
					Q7017	48T60555F01	2SC3298		
					Q7018	48T60555F01	2SC3298		
					Q7019	48T60556F01	2SA1306		
					Q7020	48T60556F01	2SA1306		
					Q7021	48S43525F03	2SC1815		
					Q7022	48S43525F03	2SC1815		
Diodes/LED's									
					D1001	48T80317F01	Twin D5KC20H		
					D1002	48T80317F01	Twin D5KC20H		
					D1003	48T80317F02	Twin D5KC20RH		
					D1004	48T80317F02	Twin D5KC20RH		
					D2001	48S40477U01	IN4003		

Symbol No.	Part No.	Description			Symbol No.	Part No.	Description		
D5001	48S40477U01	IN4003			Switches				
D5002	48S40477U01	IN4003			S2001	40T90662F02	Rotary SLD SSSR (CARTRIDGE SELECTOR)		
D5003	48S40477U01	IN4003			S2101	40T90663F01	Rotary SLD SSSR (REC OUT SELECTOR)		
D5004	48S40477U01	IN4003			S7001	40T90663F01	Rotary SLD SSSR (OUTPUT SELECTOR)		
D5005	48S40477U01	IN4003			Jacks				
D5006	48S40477U01	IN4003			J2001	09T90669F01	Phono, Plate (AU) (2P)		
D5007	48T68764F03	1S2473			J2101	09T90670F01	Phono, Plate (AU) (18P)		
or	48T43189F01	1S1555			J7001	09T90672F02	Phono, Plate (AU) (4P)		
D5008	48T68764F03	1S2473			Capacitors				
or	48T43189F01	1S1555			C1001	23T00142L22	ELY., 3300 μ F/50V		
D5015	48T68764F03	1S2473			C1002	23T00142L22	ELY., 3300 μ F/50V		
or	48T43189F01	1S1555			C1003	23T00154L53	ELY., 22 μ F/100V		
D5021	48T68764F03	1S2473			C1004	23T00154L53	ELY., 22 μ F/100V		
or	48T43189F01	1S1555			C1005	23T00154L27	ELY., 220 μ F/35V		
D5022	48T68764F03	1S2473			C1006	23T00154L27	ELY., 220 μ F/35V		
or	48T43189F01	1S1555			C1011	08T57705F25	MYL., 0.047 μ F		
D7001	48S40477U01	IN4003			C1012	08T57705F25	MYL., 0.047 μ F		
LD2001	48T52953F03	LED, BR5507S (RED)			C1013	23T00154L53	ELY., 22 μ F/100V		
LD2002	48T52953F03	LED, BR5507S (RED)			C1014	23T00154L53	ELY., 22 μ F/100V		
LD7001	48T52953F03	LED, BR5507S (RED)			C1015	23T00154L53	ELY., 22 μ F/100V		
LD7002	48T52953F03	LED, BR5507S (RED)			C1016	23T00154L53	ELY., 22 μ F/100V		
ZD1001	48T52741F03	Zener, HZ6A-3L			C1021	08T81196F03	MIC., 3pF		
ZD1002	48T52741F03	Zener, HZ6A-3L			C1022	08T81196F03	MIC., 3pF		
ZD1003	48T52741F03	Zener, HZ6A-3L			● C1031	08T52714F17	CER., 0.022 μ F		
ZD1004	48T52741F03	Zener, HZ6A-3L			● C1051	21T68834F01	CER., 0.01 μ F		
ZD1005	48T52741F03	Zener, HZ6A-3L			● C1052	21T68834F01	CER., 0.01 μ F		
ZD1006	48T52741F03	Zener, HZ6A-3L			● C1053	21T68834F01	CER., 0.01 μ F		
ZD1007	48T52741F03	Zener, HZ6A-3L			C2001	08T52714F17	CER., 0.022 μ F		
ZD1008	48T52741F03	Zener, HZ6A-3L			C2002	08T52714F17	CER., 0.022 μ F		
ZD5001	48T52739F40	Zener, HZ6C-1			C2003	08T61642F27	MIC., 100pF		
ZD5002	48T52739F03	Zener, HZ2B-3			C2004	08T61642F27	MIC., 100pF		
Coils					C2005	08T81196F25	MIC., 47pF		
L2001	24T63929F17	Choke, 15 μ H			C2006	08T81196F25	MIC., 47pF		
L2002	24T63929F17	Choke, 15 μ H			C2007	08T81196F34	MIC., 100pF		
L2003	24T63929F17	Choke, 15 μ H			Relays				
L2004	24T63929F17	Choke, 15 μ H			RL2001	80T00048L02	RZ-12W-OH		
Relays					RL7001	80T00048L02	RZ-12W-OH		

Notes: ● : For West Germany model only (AD), ▲ : For Canadian model only (UQ), Others : Common.

Symbol No.	Part No.	Description			Symbol No.	Part No.	Description		
Video Amp P. C. Board					Tone Amp P. C. Board				
Transistors					IC's				
Q3001	48T81103F01	2SC1740			IC4001	51T72167F01	M5220L		
Q3002	48T81103F01	2SC1740			IC4002	51T72167F01	M5220L		
Q3003	48T81103F01	2SC1740							
Q3004	48T81103F01	2SC1740							
Q3005	48T81103F01	2SC1740							
Q3006	48T81103F01	2SC1740							
Q3007	48T81103F01	2SC1740							
Q3008	48S40832F03	2SC1318NC							
Diodes					Capacitors				
D3001	48S40477U01	IN4003			C4001	23T00154L17	ELY., 22 μ F/25V		
ZD3001	48T52739F60	Zener, HZ9C-3			C4002	23T00154L17	ELY., 22 μ F/25V		
					C4003	23T00154L17	ELY., 22 μ F/25V		
					C4004	23T00154L17	ELY., 22 μ F/25V		
					C4005	23T00138L27	ELY., 10 μ F/25V		
					C4006	23T00138L27	ELY., 10 μ F/25V		
					C4007	23T00138L27	ELY., 10 μ F/25V		
					C4008	23T00138L27	ELY., 10 μ F/25V		
					C4009	23T00138L27	ELY., 10 μ F/25V		
					C4010	23T00138L27	ELY., 10 μ F/25V		
Relay/Jack					C4011	08T81196F34	MIC., 100pF		
RL3001	80B42571P03	Relay, (G2E) 12V			C4012	08T81196F34	MIC., 100pF		
J3001	09T90671F01	Phono, Plate (AU) 4PV			C4013	23T00138L27	ELY., 10 μ F/25V		
					C4014	23T00138L27	ELY., 10 μ F/25V		
					C4015	08T81196F14	MIC., 22pF		
					C4016	08T81196F14	MIC., 22pF		
					C4017	08T57851F01	PF, 0.01 μ F		
					C4018	08T57851F01	PF, 0.01 μ F		
					C4019	08T57851F12	TF., 0.082 μ F		
					C4020	08T57851F12	TF., 0.082 μ F		
					C4021	08T57851F32	PF, 4700pF		
					C4022	08T57851F32	PF, 4700pF		
Capacitors					Volumes				
C3001	23T00138L12	ELY., 100 μ F/10V			VR4001	18T90658F01	Rotary 250K ohm (BALANCE)		
C3002	23T00138L12	ELY., 100 μ F/10V			VR4002	18T90657F01	Rotary 10K ohm Bx2 (BASS)		
C3003	08T55260F49	CER., 1000pF			VR4003	18T90657F01	Rotary 10K ohm Bx2 (TREBLE)		
C3004	08T55260F49	CER., 1000pF							
C3005	23T00138L18	ELY., 22 μ F/16V							
C3006	23T00138L18	ELY., 22 μ F/16V							
C3007	23T00138L18	ELY., 22 μ F/16V							
C3008	23T00138L18	ELY., 22 μ F/16V							
C3009	23T00138L18	ELY., 22 μ F/16V							
C3010	23T00138L18	ELY., 22 μ F/16V							
C3011	08T81196F25	MIC., 47pF							
C3012	08T81196F25	MIC., 47pF							
C3013	23T00138L15	ELY., 470 μ F/10V							
C3014	23T00138L15	ELY., 470 μ F/10V							
C3015	23T00138L20	ELY., 47 μ F/16V							
C3016	23T00138L20	ELY., 47 μ F/16V							
C3021	23T00138L26	ELY., 4.7 μ F/25V							
C3022	23T00138L18	ELY., 22 μ F/16V							
C3023	23T00136L20	ELY., 1000 μ F/10V							
C3024	23T00140L17	ELY., (B.P.) 33 μ F/16V							
C3027	23T00138L18	ELY., 22 μ F/16V							
C3028	23T00138L18	ELY., 22 μ F/16V							

Symbol No.	Part No.	Description			Symbol No.	Part No.	Description		
Tone Switch P. C. Board					LED P. C. Board				
Switch					LED's				
S4101	40T90666F01	Push (SPUN) (SUBSONIC, MONO, TONE IN)			LD8001	48T70949F01	SLR54DC3F (ORG)		
					LD8002	48T70949F01	SLR54DC3F (ORG)		
					LD8003	48T70949F01	SLR54DC3F (ORG)		
					LD8004	48T68847F01	SLR-54MC3 (GRN)		
					LD8005	48T68847F01	SLR-54MC3 (GRN)		
Capacitors									
C4101	08T57851F21	TF., 0.47 μ F			LD8006	48T68847F01	SLR-54MC3 (GRN)		
C4102	08T57851F21	TF., 0.47 μ F			LD8007	48T68847F01	SLR-54MC3 (GRN)		
C4103	08T57851F22	TF., 0.56 μ F			LD8008	48T68847F01	SLR-54MC3 (GRN)		
C4104	08T57851F22	TF., 0.56 μ F			LD8009	48T68847F01	SLR-54MC3 (GRN)		
					LD8010	48T68847F01	SLR-54MC3 (GRN)		
					LD8011	48T68847F01	SLR-54MC3 (GRN)		
Loudness Switch P. C. Board					Miscellaneous				
Switch/Capacitors									
S4201	40T90667F01	Switch, Push (SPUN) (LOUDNESS)			C1101	08T57437F11	CAP., CER., 0.01 μ F		
C4201	08T57705F04	MYL., 820pF			▲ C1102	08T57437F11	CAP., CER., 0.01 μ F		
C4202	08T57705F04	MYL., 820pF			● F1001	65T42077U14	Fuse, Semko T630mA		
C4203	08T57705F19	MYL., 0.015 μ F			● F1002	65T42077U14	Fuse, Semko T630mA		
C4204	08T57705F19	MYL., 0.015 μ F			● F1003	65T42077U14	Fuse, Semko T630mA		
Main Volume P. C. Board									
Volume									
VR4301	18T91013F01	Rotary 100K ohm Bx2 (VOLUME CONTROL)			● F1101	65T42077U10	Fuse, Semko T250mA		
					▲ F1101	65T52486F03	Fuse, MF 61NM 1A		
					▲ J1001	09T67405F02	Outlet, AC		
					J7101	09T66672F01	PHONES Jack (phones)		
Function Switch P. C. Board									
Switch									
S6001	40T90665F01	Push (SPUN) (VIDEO-1, -2, TUNER, CD, PHONO)			LD8101	48T70949F01	LED, SLR54DC3F (ORG)		
					● P1001	28T43812P05	AC Power Cord		
					▲ P1001	28T66838F01	AC Power Cord		
					● S1101	40T84122F01	Switch, Power SDDLE		
					▲ S1101	40T80736F01	Switch, Power SDDZB1		
					● S1102	40T80258F02	Switch, Voltage Select		
					● T1001	25T92778F01	Trans, Power		
					▲ T1001	25T92779F01	Trans, Power		
Tape Monitor Switch P. C. Board									
Switch									
S6101	40T90668F01	Push (SPUF) (TAPE MONITOR, TAPE/DAT, STRAIGHT IN, STRAIGHT SELECTOR)							

Notes : ● : For West Germany model only (AD), ▲ : For Canadian model only (UQ), Others : Common.

Cabinet Assembly Parts List

NOTE : The parts without part numbers are not supplied.

Symbol No.	Index	Part No.	Description			Symbol No.	Index	Part No.	Description		
	1	5-A	01V91300F98	Assy., Front P.C. Board							
●	2	2-G	15C83872F03	Cover, Top							
	4	4-F	15C90578F01	Cover, Rear							
▲	4	4-F	15C90578F02	Cover, Rear							
	5		03S71031F04	Screw, Bind (M3 × 8)							
	6		03S82672F20	Screw, Bind (M3 × 8)							
	7	5-D	75T57059F01	Pad, Tranleg							
	8	6-D	03S63857F10	Screw, Tapping (M4 × 12)							
	10		03S44205G4Q	Screw, Bind (M3 × 4)							
	13		05B41635J02	Rivet Push							
●	14	2-D	14S53017F64	Insulator, Cover							
▲	14		54A63397F01	Label, Fuse Caution							
	15		03S44205G69	Screw, Bind (M4 × 6)							
	16	4-F	75S92415F11	Cushion, Rubber							
●	17	1-B	47A90587F01	Shaft, Power							
▲	17	1-B	47A92022F01	Shaft, Power							
	18	1-C	43A83885F01	Spacer, Rubber							
	21		03D40014G04	Screw, W/Washer (M3 × 6)							
	28		43T53136F01	Bush, Cap							
	29	4-H	43B41625J02	Support, Cord							
	30	4-H	29T66964F02	Terminal, GND (AU)							
	31	5-H	14A93742F01	Double, Face Jack							
●	35		09T51410F01	Holder, Fuse (Semko)							
▲	35	4-D	09T51960F01	Holder, Fuse (Semko)							
	36		29C41045P06	Lug, Board-In 50mm							
	37		29A41814G01	Lug							
	41	4-A	03S44205G50	Screw, Countersink (M3 × 6)							
	42	3-A	36B70885F08	Knob, Push (Power)							
	43		36A67333F02	Knob, Push (3 × 10)							
	44	4-A	36R61696F01	Knob, Main (1163 Metal)							
	45	4-B	36A61760F01	Knob, Rotary (VR1163)							
	46	3-A	36A61435F01	Knob, Volume (1164)							
	47	4-C	36B90588F01	Knob, Rotary Volume							
	48	3-A	36A57910F03	Knob, Rotary							
	50		03S71031F01	Screw, Bind (M3 × 8)							
	51	3-D	40T90660F01	Switch, Rotary							
	52	3-D	40T90659F01	Switch, Rotary							
	53	2-A	40T90661F01	Switch, Rotary							

Notes : ● : For West Germany model only (AD), ▲ : For Canadian model only (UQ), Others : Common.

Packing Assembly Parts List

Symbol No.	Part No.	Description			Symbol No.	Part No.	Description		
101-1	68P83710F05	Owners Manual			105	56D90649F01	Tray, Packing		
101-2	28T67347F01	Plug, Audio Cable (AU)			106	56A93246F01	Pad, Packing		
102	56B40230G23	Sack, Polyethylene			107	56B40230G08	Sack, Polyethylene		
103	56S83833F14	Carton, Packing							
104	56D90648F01	Tray, Packing							

Packing Method View

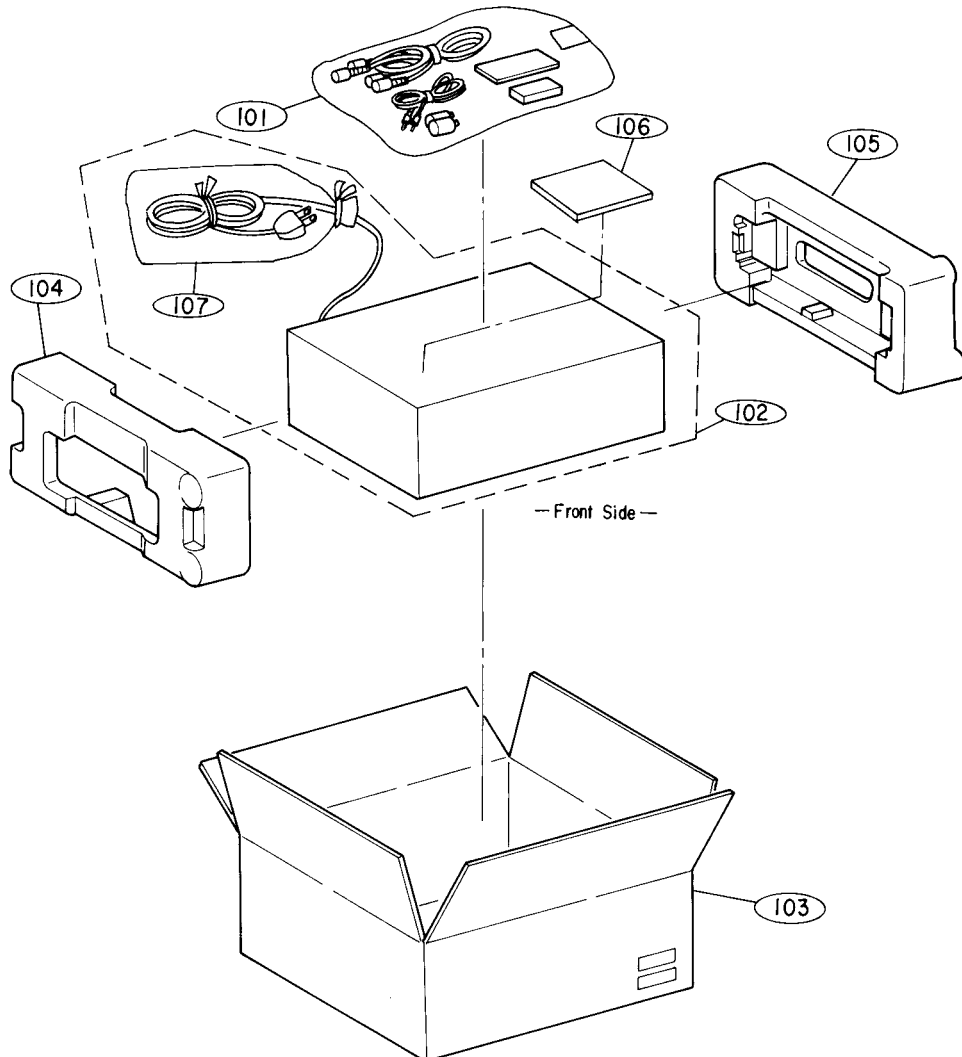

Semi-Conductor Lead Identifications

M5220L : IC2001, 2002, 4001, 4002

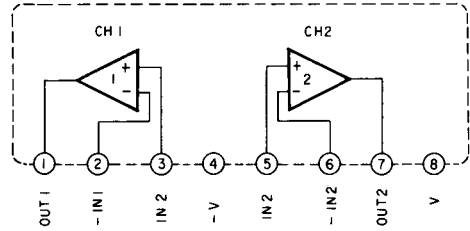
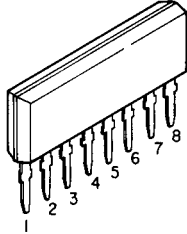

TA7317P : IC5001

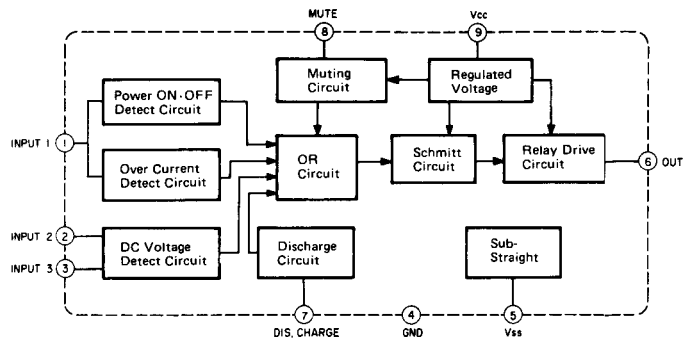
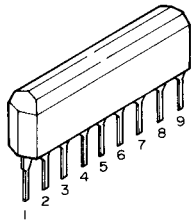

NJM78M12A : IC5002

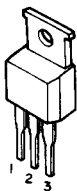

1: INPUT
2: COMMON
3: OUTPUT

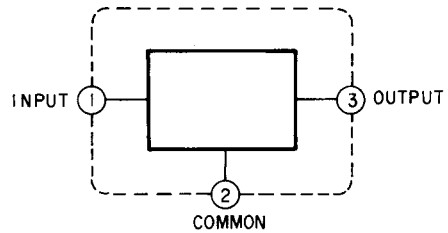

2SK30A : Q1001, 1002, 1015, 1016



2SC1815 : Q1003, 1008, 1010, 1012, 1020, 1022, 1024, 2005, 2006, 5002, 5005
: Q5021, 5022, 5023, 7003, 7004, 7009, 7010, 7011, 7012, 7021, 7022

2SA1015 : Q1004, 1007, 1009, 1011, 1019, 1021, 1023, 5003, 5004

2SC1740 : Q3001, 3002, 3003, 3004, 3005, 3006, 3007

2SC1318NC : Q3008

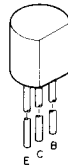

2SC3298 : Q1005, 7017, 7018

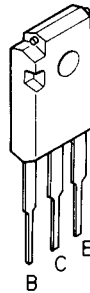

2SA1306 : Q1006, 7019, 7020

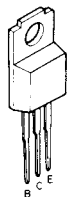

2SA798 : Q1014, 1026, 7007, 7008

2SC1583 : Q1013, 1025

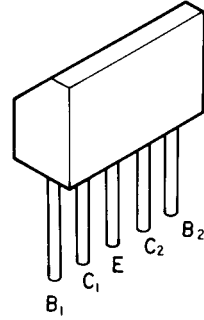

2SC3423 : Q1017

2SA1360 : Q1018



2SK240 : Q2001, 2002

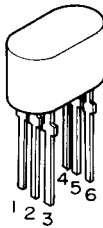

- 1: DRAIN 1
- 2: GATE 1
- 3: SOURCE 1
- 4: DRAIN 2
- 5: GATE 2
- 6: SOURCE 2

2SC2291 : Q2003, 2004, 7005, 7006

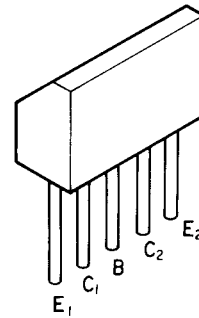

2SK332 : Q7001, 7002

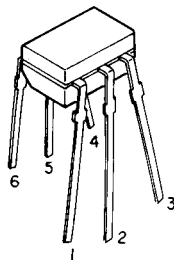

- 1: DRAIN 1
- 2: GATE 1
- 3: SOURCE 1
- 4: SOURCE 2
- 5: GATE 2
- 6: DRAIN 2

2SA1208 : Q7015, 7016

2SC2910 : Q7013, 7014

